

Taurus Planetary Countercurrent Mixer

PGM 750 - 500

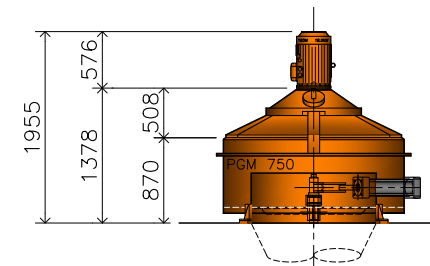
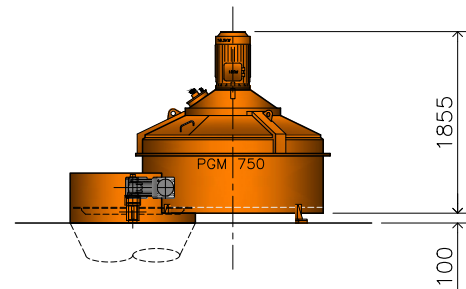
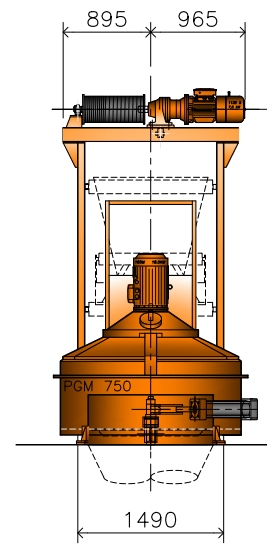
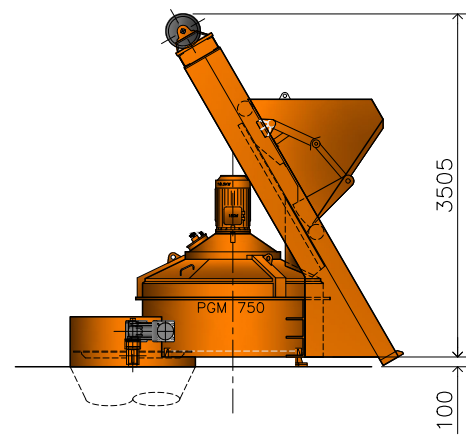
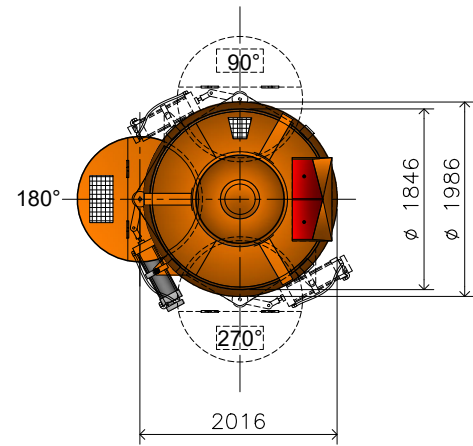

Technical data Planetary Mixer Taurus PGM 750 / 500

Dry filling capacity	Ltr	750
Output per batch, compacted	Ltr	500
Mixer drive motor	kW	18
Mixing stars	n°	1
Mixing shovels / mixing star	n°	3
Mixing shovels width	mm	3 x 360
Side scrapers	n°	1
Side scrapers width	mm	480
Speed of rotor	Rpm	14,6
Speed of mixing stars	Rpm	42,6
Water spray nozzles	n°	6
Weight of mixer	kg	2950

Technical data Skip-Hoist Taurus PGM 750 / 500

Dry filling capacity	Ltr	750
Max filling weight	kg	1100
Hoist drive motor	kW	9
Speed of hoist up / down	n°	0,4 / 0,8
Dia. of hoisting wire	mm	11

